

EXCLUSIVE USA DISTRIBUTION

INFINIUM[®]



Lemi Monza



*Lemi
Dreamed*



Lemi 4

LemiMD
ITALIAN MEDICAL EQUIPMENT

Procedure Series

Compact & Mobile Procedure Platform

- Tapered mid-section
- Removable articulating headrest
- Easy-lock smooth casters
- Hand & foot controls
- Accessory side-rails
- Quiet power height, back, leg rest, & trend
- 21.6" barrier-free low height access

Chair Height: 21.6" to 33.8"

Mattress Width: 23.2"

Mattress Length: 61.8" to 73.2"

Chair Weight: 183 lbs



Load Capacity: 441 lbs



Integrated Wheels

High quality front and rear casters with easy to use breaking system.

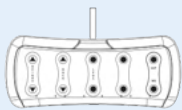

4M

4 ELECTRIC MOTORS



M1 - MEMORY FUNCTION

AUT

AUT FUNCTION



Easy-to-clean anatomic mattress without stitching

Electric Trendelenburg



15°



Electric height

55-86 cm
(21,6"-33,8")



75°

Electric backrest

90° leg inclination
Electric legrest



90°

THICKNESS
12cm | 4.7"

Power Procedure Chair Form Meets Function

- Tapered surgery access
- Adjustable head rest
- Premium easy-to-clean fire resistant medical fabric
- Built-in arm rests
- Quiet power height, back, leg rest, & trend functions
- 20" barrier-free low height
- Hand and foot controls

Chair Height: 21" to 33"
Mattress Width: 22.8"
Mattress Length: 61.6" to 72.8"
Chair Weight: 166 lbs



Load Capacity:
 441 lbs

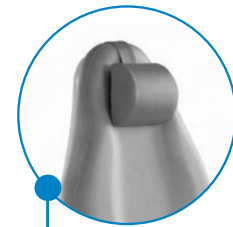

Tapered Headrest Access

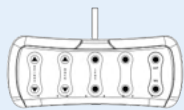

4M

4 ELECTRIC MOTORS



M1 - MEMORY FUNCTION



AUT FUNCTION



Electric Trendelenburg



90° rotation on both sides



Power Procedure Table

Affordable Luxury & Performance

- Flexible removable headrest options
- Hand and foot controls included
- Accessory base rails
- Premium easy-to-clean fire and bacteria resistant medical fabric
- Smooth power height, back, leg rest, & trend adjustments
- Automatic return to chair function



Load Capacity:
440lbs

Chair Height: 24.8" to 35.6"

Mattress Width: 24.4"

Mattress Length: 74.8" to 90.6"

Chair Weight: 172 lbs

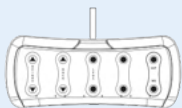

4M

4 ELECTRIC MOTORS



M1 - MEMORY FUNCTION

AUT

AUT FUNCTION

SYNCHRO

SYNCHRO FUNCTION



THICKNESS
12cm | 4.7"



Removable headrest options



Electric legrest



REMOVABLE HEADREST OPTIONS

*AVAILABLE ON SELECT CHAIRS

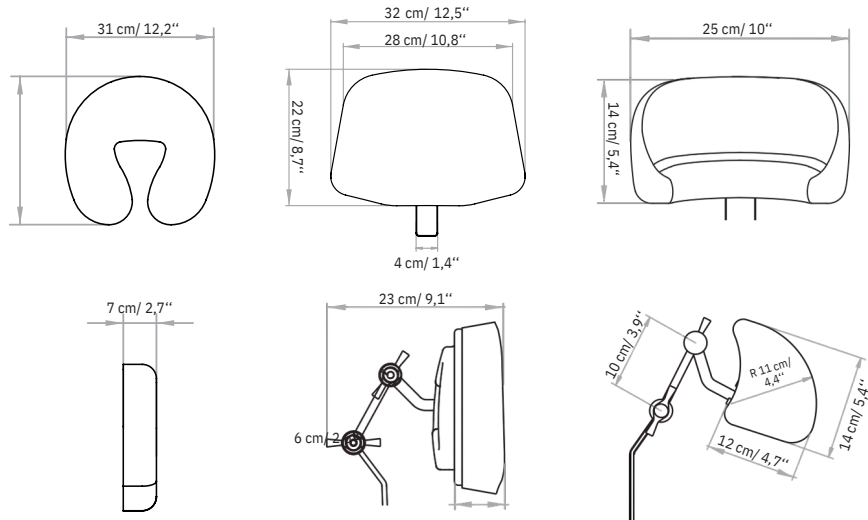

COMMON ACCESSORY OPTIONS

*AVAILABLE ON SELECT CHAIRS



I.V. Rod
(fixed with rotating clamp and guides on the back)



Headrest



Fixed clamp

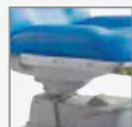

Seat guide couple



Ophthalmological headrest



Rotating clamp



Cushion between seat and leg



Medical armrest couple
(to be fixed with rotating clamp and guides on the back)

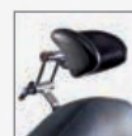

Anto headrest for full head access



Plastic leg protection



Blood sample taking armrest couple



Strip headrest



Mayo tray with support
(fixed with fix clamp and guides on the seat)



Heel support couple
(fixed with fix clamp and guides on the seat)



Roll Holder



Thigh supports couple
(fixed with fix clamp and guides on the seat)



Curtain holder
(fixed with rotating clamp and guides on the seat)



USA cable

ADVANCED Nefos FABRIC Technology



STANDARD NEFOS FABRIC



SPECIAL ORDER

The **Nefos** vinyl leather fabric is made through production processes involving an antimicrobial additive technology. Studies show that fabrics treated with this technology are up to 99.9% resistant to harmful bacteria.

CUSTOM FABRIC COLORS



The innovative Nefos materials - which are exclusive for LEMI products - and their special finishing touch guarantee easy-cleaning and hygiene. Their extraordinary structural qualities will persist through the years. An incredibly elastic texture enhances the mattress softness and quality at its best.

The images are for illustrative purposes only and may not reflect the actual finish of the product, particularly when viewed through a screen. Therefore, the **SELECTION OF MATTRESS FABRICS** must take place **AFTER CONSULTING** the **PHYSICAL SAMPLES** of the **COLOR CHARTS**. Allow an addition **8-10 weeks** for custom fabric orders.

STANDING BEHIND YOUR INVESTMENT

2 Year Guarantee
Full 2 year warranty on all electrical parts of the product.

5 Year Guarantee
a complete 5 year guarantee on the mattress padding.

10 Year Guarantee
On all metal parts of the product



Infinium Medical
12151 62nd St North #5
Largo, FL 33773 • USA

(1) 866-918-8434
infiniummedical.com
sale@infiniummedical.com



EXCLUSIVE USA DISTRIBUTION

