

INFINIUM[®]

Surgical Lighting



LUXOR *SERIES*



LUXOR TECHNOLOGY

Shadow Dilution (Smart sensor)

One of the essential elements in a surgical environment is the shadowless effect. All of LUXOR's shadowless lights have achieved excellent shadowless effects through proprietary optical design technology. Even if the surgical area is covered, the motion sensor automatically compensates for the illuminance value.



Depth of Illumination (Smart sensor)

Depth of illumination is one of the main functions of operation and it refers to the degree of maintaining a uniform illuminance environment despite the different working distance. LUXOR Lights ensures that the central illuminance remains at 160,000lx from 31.50in to 51.18in, high depth of field is effective in cases where the surgical area is narrow and deep.

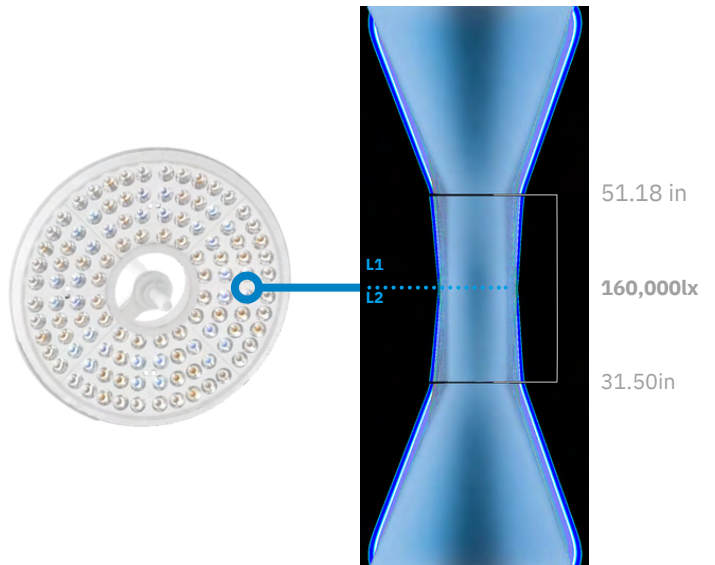

LUXOR TECHNOLOGY

Hybrid LED System

A Hybrid optical system is a hybrid product that combines a reflector and shield. It performs various functions such as color temperature and light field diameter adjustment with low power consumption. Also, a hybrid LED system was used to enhance the color separation effect, in result it allows eye comfort during the surgery.

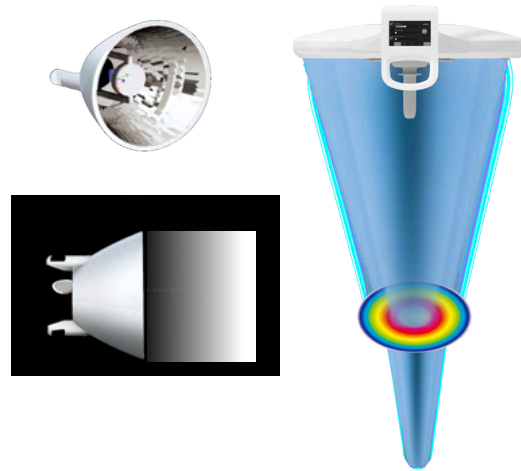

High Color Rendering Index

Ra 99/R9 99/R13 99 LUXOR Lights suggests high CRI which may realize more clear and nature-like color. LUXOR Lights using color filter lens exhibits high color rendering spectrum (Ra 99/R9 99) by lowering the blue wavelength (450nm) and increasing the green (500nm) and red (600nm) wavelengths. It helps to reduce the eye fatigue compared to higher brightness with low CRI.

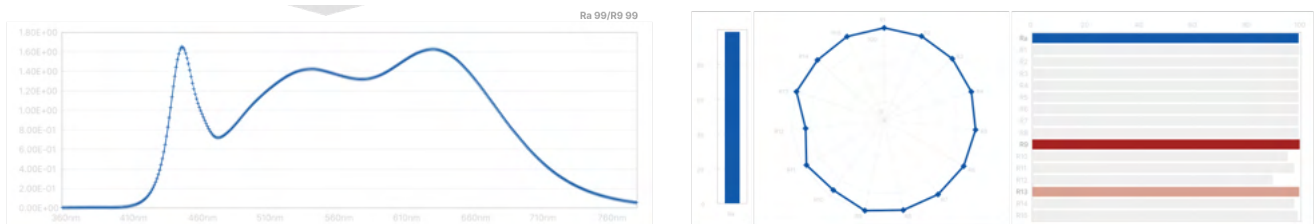

Intuitive Control Panel

ADJUSTABLE FOR SPECIFIC PROCEDURES

- Intensity can be adjusted from 16,000lx to 160,000lx continuously (Endo mode: 1,600lx-16,000lx).
- Light Field Diameter can be adjusted from 7.09 to 13.39in continuously.
- Color Temperature can be adjusted from 3,600K to 5,400K continuously.





LUXOR | L400

OPERATING LIGHTS

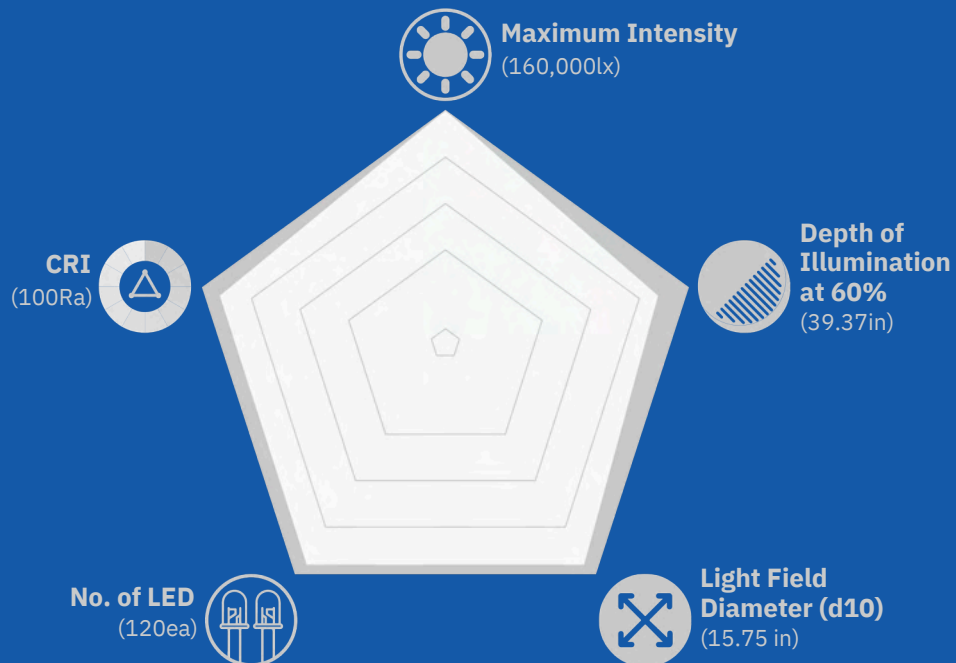

LUXOR | L400



	<p>Illumination Intensity Continuous adjustment (Max. 160,000lx)</p>		<p>Color Rendering Index Ra 99/R9 99/R13 99</p>
	<p>Light Field Diameter 7.09 to 13.39 in</p>		<p>Smart Sensor Enhancement of shadow dilution & depth of illumination</p>
	<p>Color Temperature 3,600K-5,400K</p>		<p>ENDO Mode Suitable for endo-surgery by one click, Ec*5%</p>
			<p>Synchronized Control One controller can control the other at the same time</p>

Continuously Adjustable Light Intensity, Color Temperature and Light Field Diameter

Light intensity (Maximum 160,000lx)
Color temperature (3,600K-5,400K)
Light field diameter (7.09 to 13.39 in)



Smart Sensor in Surgical Lights

Detects movements by the surgeon or medical staff, allowing them to adjust the light's intensity



Synchronized Control

A synchronization system provides convenience and efficiency by allowing two lights to be controlled simultaneously



Optional 4K / Full HD Camera

Optional Features

Full-HD Camera

Classification	Specification
Image Sensor	1/2.8-type CMOS
Image Point	Approx. 2.14 Megapixels
Lens	Optical
Focus, Aperture	Auto, Manual
Video Signal	HD-SDI(BNC)
Resolution	Full HD 1080p, 1080i, 720p, 720i

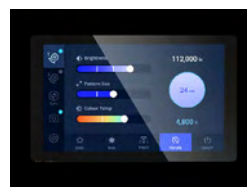

Optional Tablet PC Controller



Optional Wall Controller

LUXOR | M400



Illumination Intensity
Continuous adjustment
(Max. 140,000lx)



Color Rendering Index
Ra 99/R9 99/R13 99



Light Field Diameter
7.09 in to 11.81 in



Smart Sensor
Enhancement of shadow dilution
& depth of illumination



Color Temperature
3,600K-5,400K



ENDO Mode
Suitable for endo-surgery
by one click, Ec*5%



Synchronized Control
One controller can control the other at
the same time

Continuously Adjustable Light Intensity, Color Temperature and Light Field Diameter

Light intensity (Maximum 140,000lx) Color
temperature (3,600K-5,400K) Light field
diameter (7.09 in to 11.81 in)



Smart Sensor in Surgical Lights

Detects movements by the surgeon or
medical staff, allowing them to adjust
the light's intensity



Synchronized Control

A synchronization system provides
convenience and efficiency by allowing two
lights to be controlled simultaneously

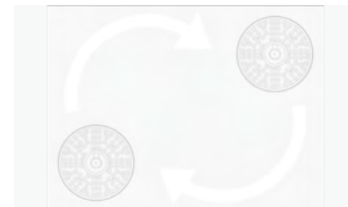

Optional Features



4K / Full HD Camera

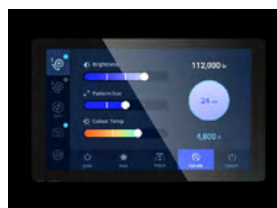

Tablet PC Controller



Wall Controller





LUXOR | 400 Configurations

Mobile . Single Ceiling . Dual Ceiling . Triple Ceiling

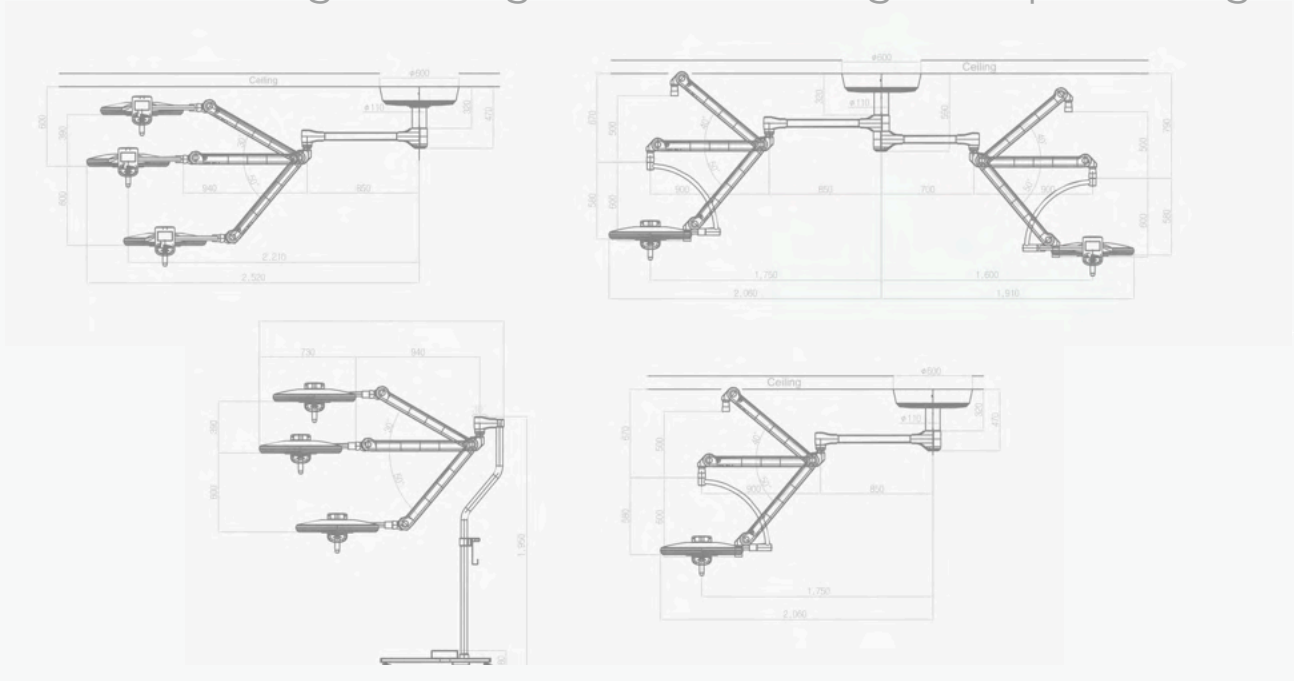

01



Single Arm
Only Light

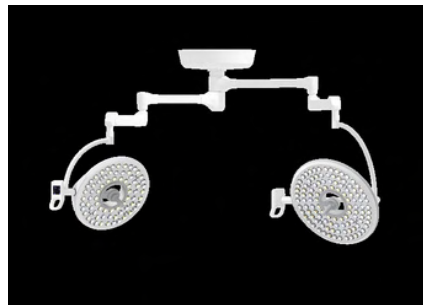

Dual Arm
Light + Light
or
Light + Monitor



Tri Arm
Light + Light + Light
or
Light + Light + Monitor

Technical Specifications

L400

M400



Head Size (in)	Ø 29.53	Ø 25.59	
No. of LED (ea)	112	72	
Central Illumination Ec (lx)	160,000	140,000	
Electronic Adjustment Range (%)	10-100 (continuous)	10-100 (continuous)	
Endo Mode (Illumination, lx)	1,600-16,000 (1-10% continuous)	1,400-14,000 (1-10% continuous)	
Color Temperature (K)	3,600-5,400 (continuous)	3,600 - 5,400 (continuous)	
Color Rendering Index (Ra/R9/R13)	99/99/99	99/99/99	
Light Field Diameter (d10, in)	7.09 to 13.39 (continuous)	7.09 to 11.81 (continuous)	
Light Field Diameter (d50, in)	3.94 to 7.48	3.94 to 7.09	
Shadow Dilution (%)	With Tube	95	100
	With 1 mask/With 1 mask+tube	92/85	85/85
	With 2 mask/With 2 mask+tube	70/65	70/70
Depth of Illumination at 60% (in)	33.46	31.50	
Illumination Energy (W/)	570	498	
Power Consumption (VA)	105	72	
Life Span (Hr)	60,000	60,000	
Detachable Centre Grip	Yes(2X)	Yes(2X)	
Certificate	CE/UL/FDA	CE/UL/FDA	
Installation Type	Single Ceiling Dual Ceiling Mobile	Single Ceiling Dual Ceiling Mobile	
Option	Full-HD Camera 4K Camera Tablet PC(App) Wall Controller	Full-HD Camera 4K Camera Tablet PC(App) Wall Controller	

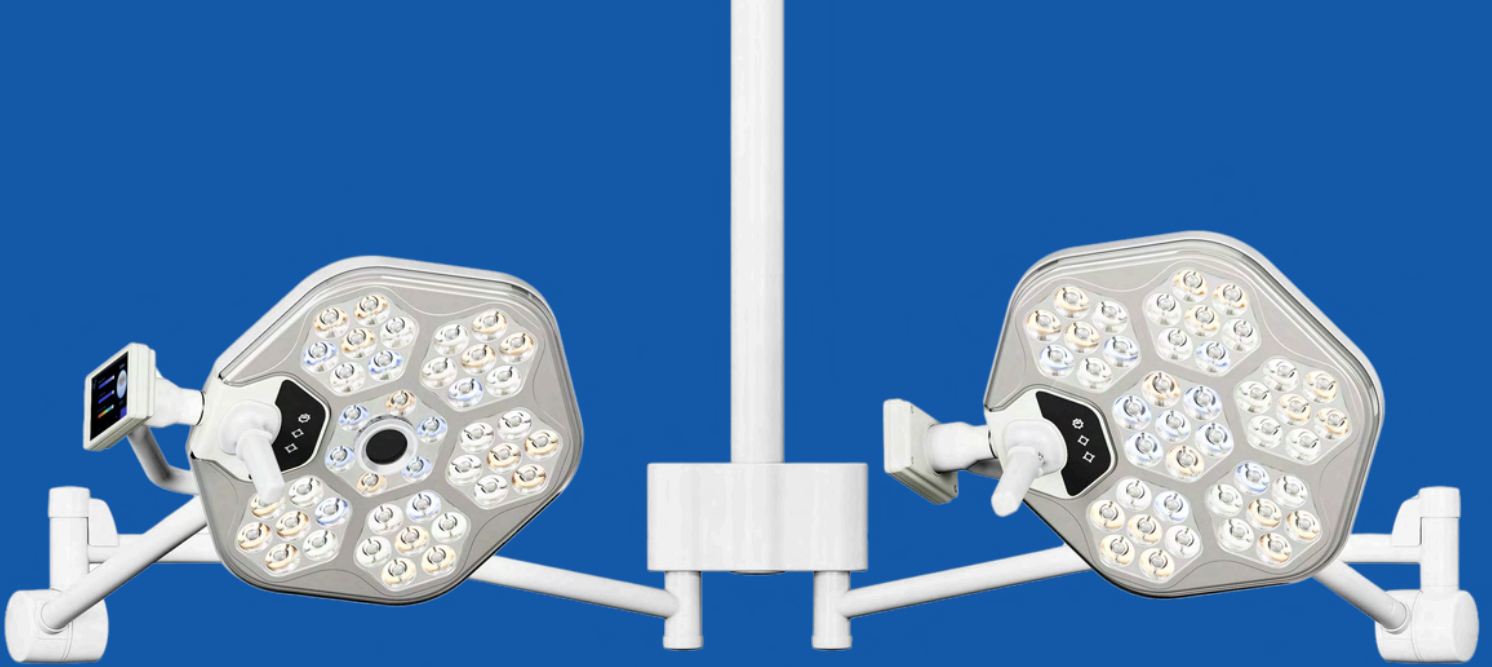

LUXOR | S300

SURGICAL LIGHTS

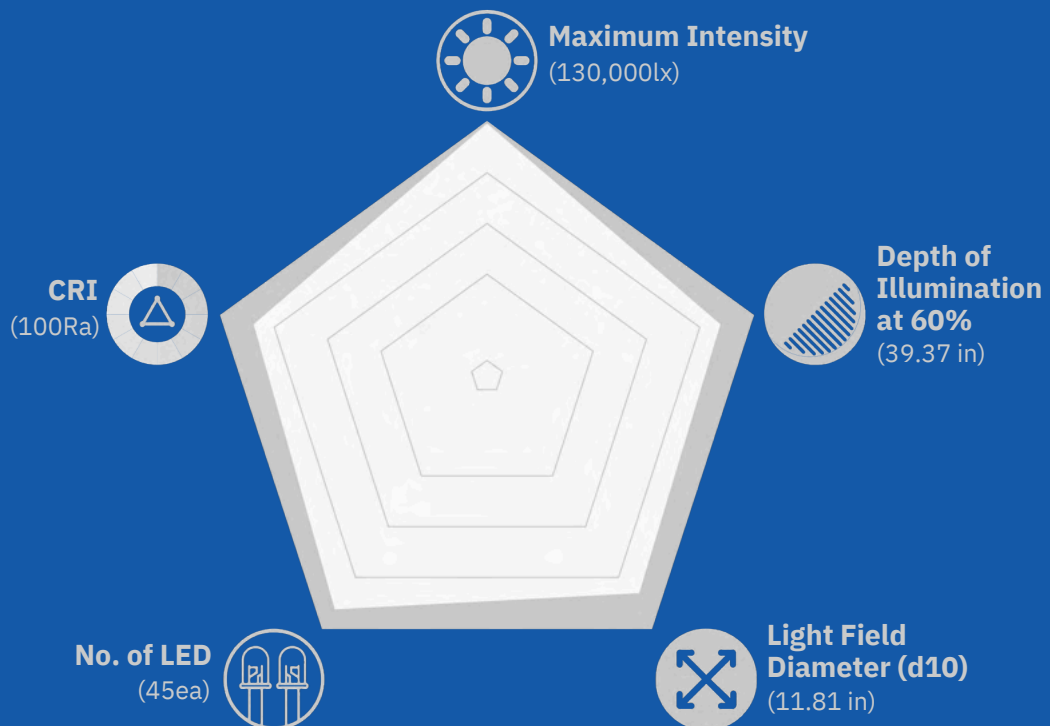

LUXOR | S300

VERSATILE MODERN PERFORMANCE



Illumination Intensity
3 Step adjustment (Max. 130,000lx)



Light Field Diameter
3 Step adjustment (5.91 to 9.84in)



Color Temperature
3,800K/4,300K/4,800K



Color Rendering Index
Ra 96/R9 95



3 Different Modes
Surgical mode (130,000lx)
Examine mode (60,000lx)
Dental mode (30,000lx)

ARM Touch Control (5" LCD)

Light (1 or 2) Control - Light 1/Light 2 select - Light ON/OFF - Light field diameter, Intensity, Color temperature

Sync Mode - Light (1 and 2) sync



Synchronized Control

A synchronization system provides convenience and efficiency by allowing two lights to be controlled simultaneously

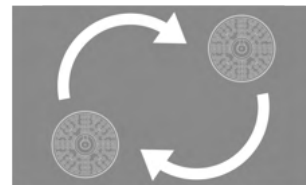

Handle Touch Control

(Quick & Easy)

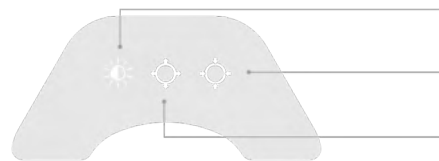

Intensity Control
(1 → 2 → 3 → 1, Rotate)

Light Field Decrease

Light Field Increase

Optional Features

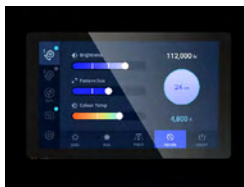

Tablet PC Controller



Remote Controller



Full-HD Camera



LUXOR | S300 Camera



Illumination Intensity
3 Step adjustment (Max. 130,000 lx)



Light Field Size
3 Step adjustment (5.91 to 9.84 in)



Color Temperature
3,800K / 4,300K / 4,800K



Color Rendering Index
Ra 96 / R9 95



Examination Mode
3 Step adjustment (Max. 60,000 lx)
Color Temp. (3,800K / 4,300K / 4,800K)

Handle Touch Control (Quick & Easy)

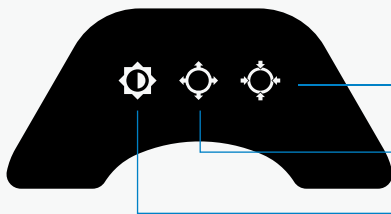

Light Field Decrease

Light Field Increase

Intensity Control(1 → 2 → 3 → 1, Rotate)

Full-HD Camera

Classification	Specification
Image Sensor	1/2.8-type CMOS
Image Point	Approx. 2.14 Megapixels
Lens	Optical
Focus, Aperture	Auto, Manual
Video Signal	HD-SDI(BNC)
Resolution	Full HD 1080p, 1080i, 720p, 720i

NEW!





LUXOR | S300 Configurations

Mobile . Wall . Single Ceiling . Dual Ceiling

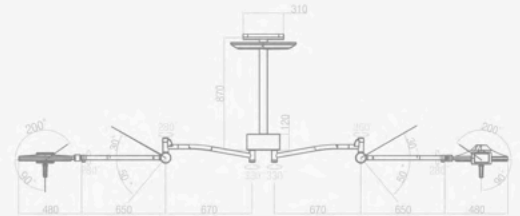
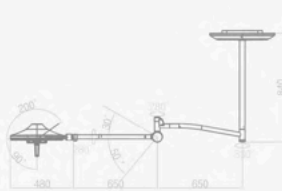
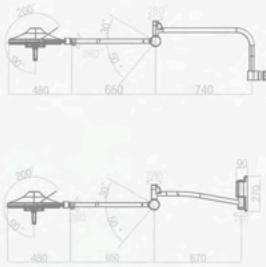
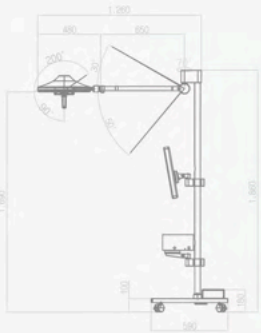

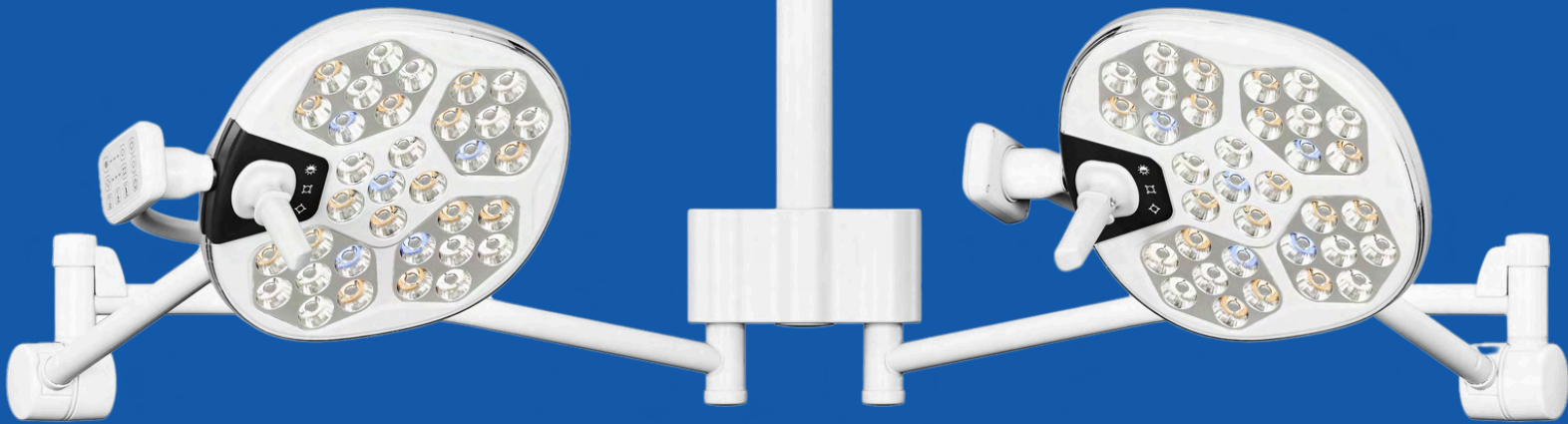

LUXOR | S250

PROCEDURE LIGHTS

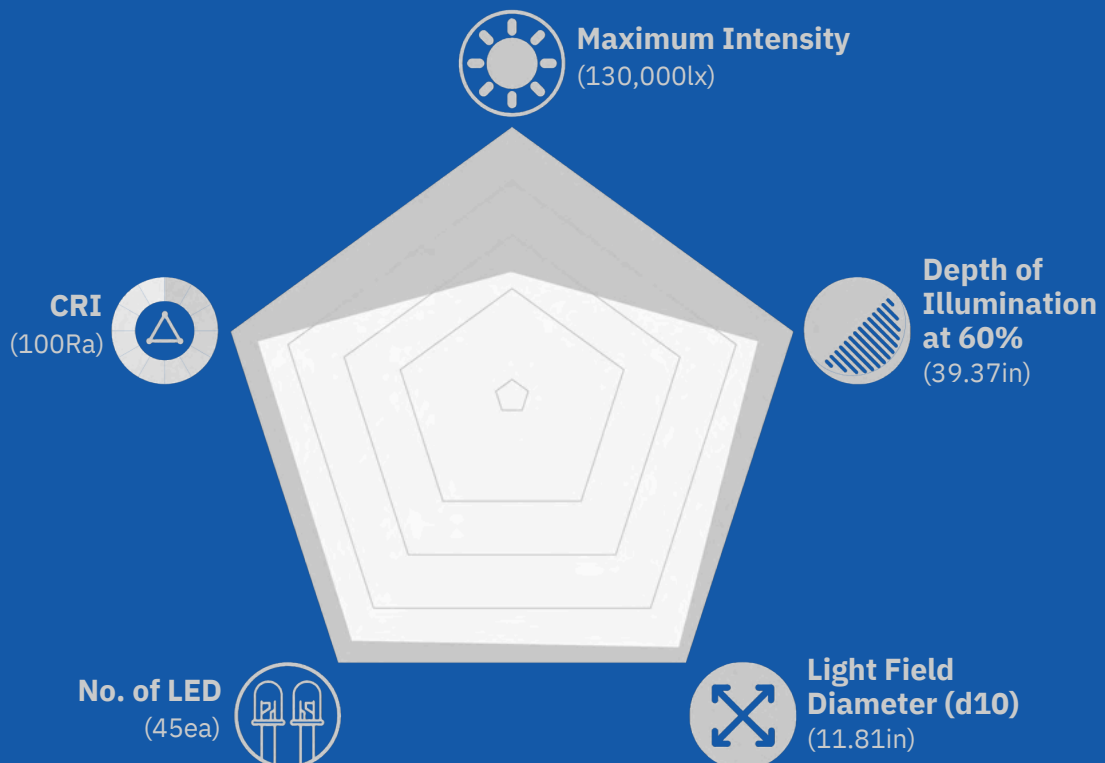

LUXOR | S250



	<p>Illumination Intensity 3 Step adjustment (Max. 110,000lx)</p>		<p>Color Rendering Index Ra 97/R9 97</p>
	<p>Light Field Diameter 3 Step adjustment (5.91 to 9.84in)</p>		<p>ENDO Mode 3 Step adjustment (5,000lx-15,000lx)</p>
	<p>Color Temperature 3,800K/4,300K/4,800K</p>		

Handle Touch Control (Quick & Easy)



ARM Touch Control

Light Control -
3 step - Brightness (Intensity)
3 step - Light field diameter
3 step - Color temperature

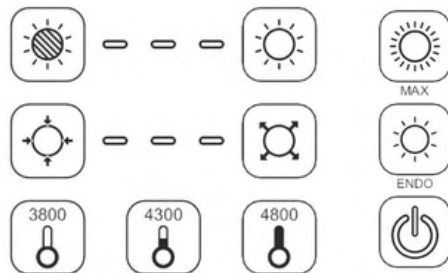

Max. Mode - Light field diameter 3 level - Intensity 3 level

Endo Mode
- Light field diameter 1 level
- Intensity & Color temperature 3 step (5,000lx-15,000lx)

Light ON/OFF

Optional Features



Remote Controller





New and Smart Design



High Energy Efficiency



Easily Adjustment

LUXOR | S250 Configurations

Mobile . Wall . Single Ceiling . Dual Ceiling

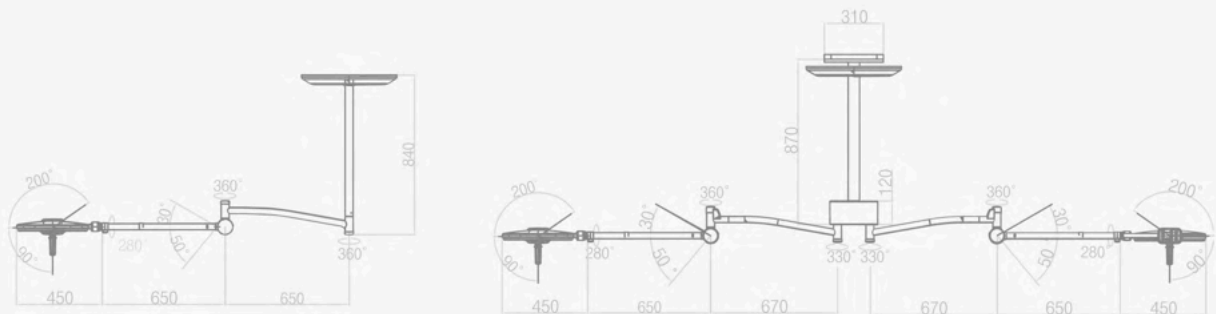
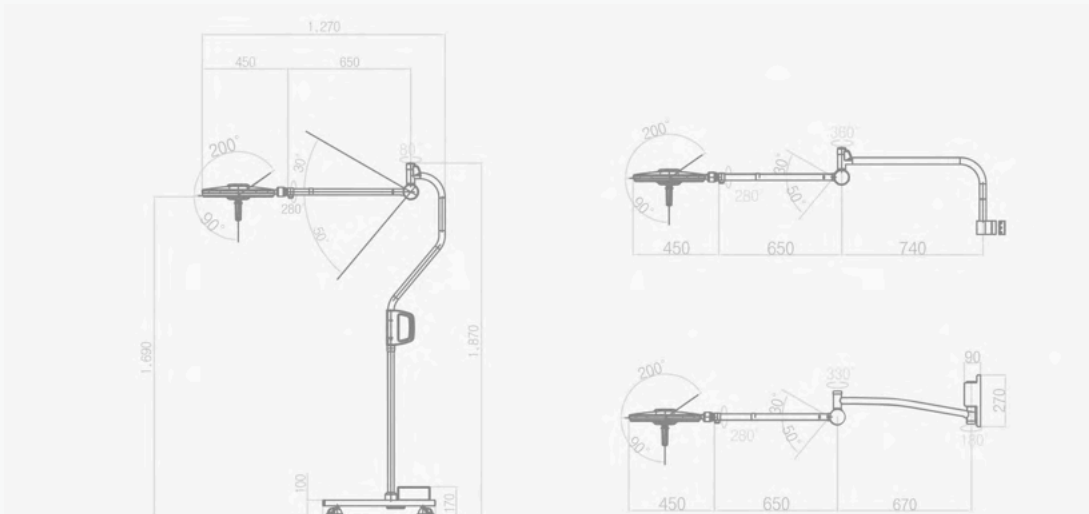



LUXOR | S200

EXAM LIGHTS

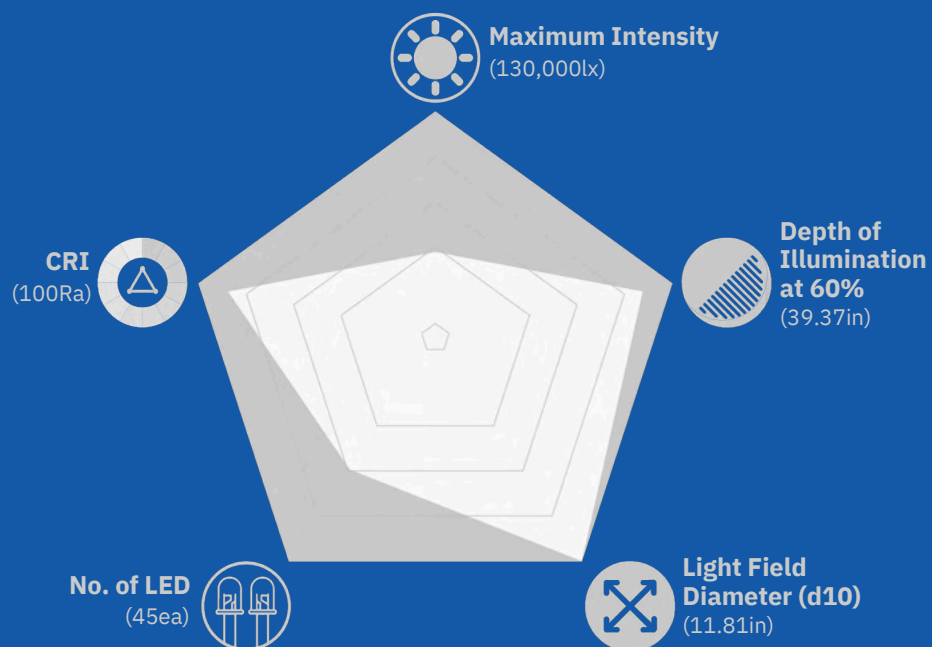

LUXOR | S200

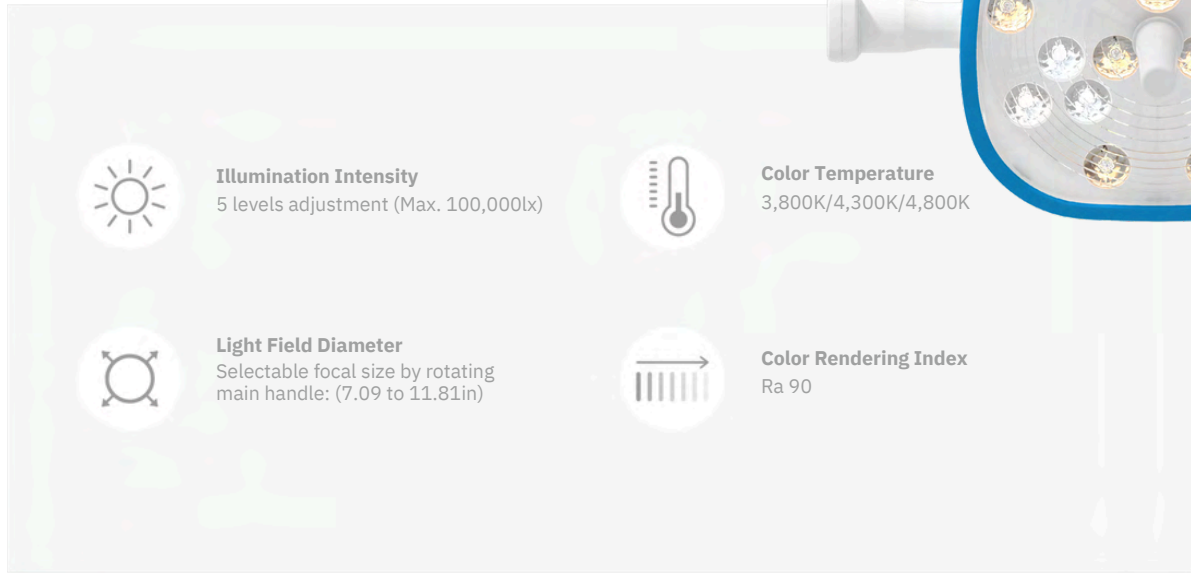

Easy Control

- Intensity: 100,000lx (Max.)
- Color temperature: 3,800K/4,300K/4,800K
- Light field diameter: (7.09 to 11.81in)

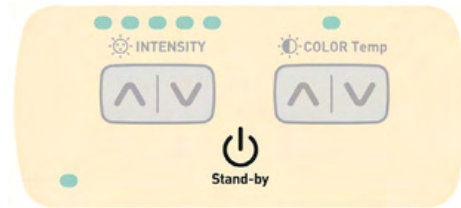

Adjustable Light Field Diameter

Light field diameter adjustment from 7.09 to 11.81in allows for light adjustment suitable for the surgical environment



Adjustable Color Temperature

The color temperature in the range 3,800K to 4,800K, provide a balance between visibility and comfort for the surgical team.





Energy Saving



Low Heating





Simple Handling

LUXOR | S200 Configurations

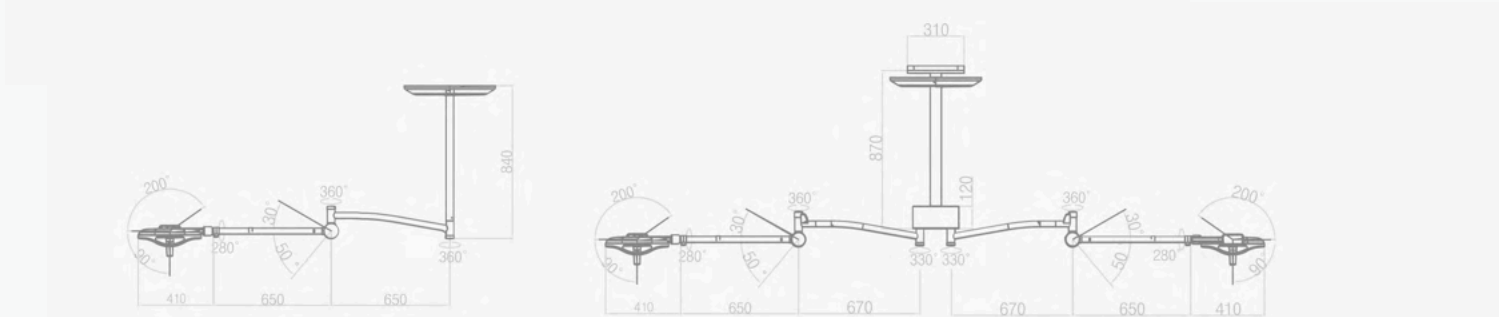
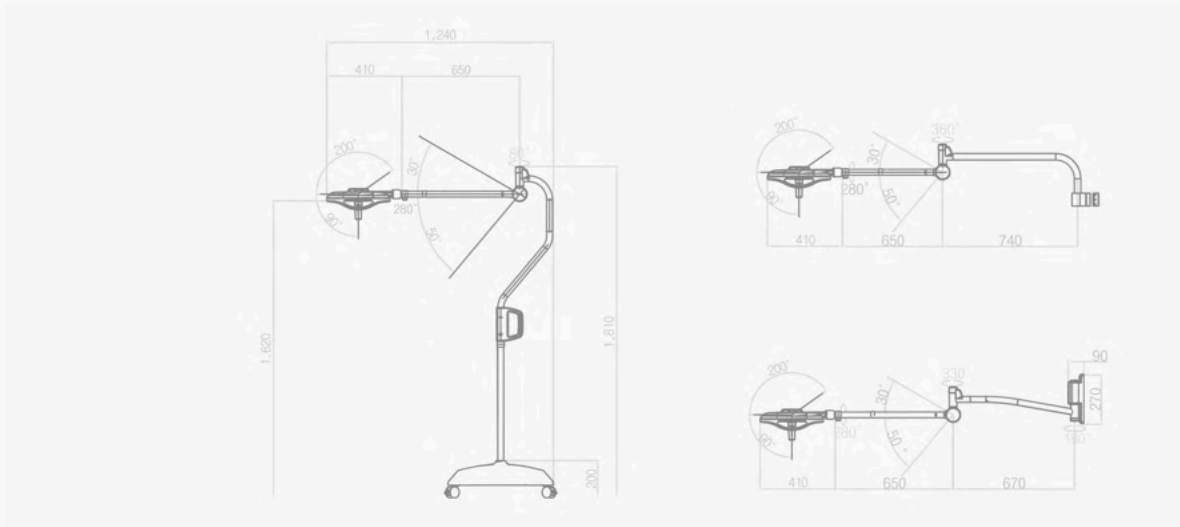
Mobile . Wall . Single Ceiling . Dual Ceiling



Technical Specifications

Model	S300	S250	S200
Design (light head)			
Head Size (cm)	20.51in x 18.46in	14.65in x 14.96in	13.78in x 13.39in x 4.33in
No. of LED (ea)	42	34	18
Central Illumination Ec (lx)	130,000	110,000	100,000
Electronic Adjustment Range (%)	40-100	40-100	5-100
Endo Mode (Illumination, lx)	-	5,000 - 15,000 (3 level)	-
Color Temperature (K)	3,800/4,300/4,800	3,800/4,300/4,800	3,800/4,300/4,800
Color Rendering Index (Ra/R9/R13)	96/95/99	97/97/99	90/80/95
Light Field Diameter (d10, in)	5.91 to 9.84	5.91 to 9.84	7.09 to 11.81
Light Field Diameter (d50, in)	3.54 to 5.91	3.54 to 5.91	3.74 to 6.50
Shadow Dilution (%)	With Tube	100	100
	With 1 mask/With 1 mask+tube	-	-
	With 2 mask/With 2 mask+tube	50/50	50/50
Depth of Illumination at 60% (in)	29.53 in	31.50 in	30.71
Illumination Energy (W/)	454	376	331
Power Consumption (VA)	61	61	45-67
Life Span (Hr)	60,000	60,000	60,000
Detachable Centre Grip	Yes(2X)	Yes(2X)	Yes(2X)
Certificate	CE/UL/FDA	CE/UL/FDA	CE/UL/FDA
Installation Type	Single Ceiling Dual Ceiling Mobile Wall	Single Ceiling Dual Ceiling Mobile Wall	Single Ceiling Dual Ceiling Mobile Wall
Option	Tablet PC(App) Backup Battery Remote Controller	Backup Battery Remote Controller	-



STANDING BEHIND YOUR INVESTMENT

5 Year Guarantee

Complete 5 year guarantee on electronics, bulbs, & parts



Infinium Medical
12151 62nd St North #5
Largo, FL 33773 • USA

(1) 866-918-8434
infiniummedical.com
sale@infiniummedical.com

INFINIUM[®]
LUXOR
Series